

Warning:

Follow each appliance's instructions precisely.

Installation and service must be performed by a trained and certified installer, service agency or the gas supplier.

Application drawings in this manual are conceptual only and do not purport to address all design, installation, code, or safety considerations.

The diagrams in this manual are for reference use by code officials, designers and licensed installers. It is expected that installers have adequate knowledge of national and local codes, as well as accepted industry practices, and are trained on equipment, procedures, and applications involved. Drawings are not to scale.

Refer to the appliance and accessory installation manuals for additional detailed information!

APPLICATIONS MANUAL

INFINITI® K 160-199

Indoor Residential and Tankless Water Heaters



LOW NOX
EMISSIONS



This Page is Intentionally Blank

TABLE OF CONTENTS

1	KEY TO SYMBOLS AND SAFETY INSTRUCTIONS	4
1.1	Key to symbols	4
1.2	Safety	4
2	INTRODUCTION	5
3	WATER HEATER SIZING AND SPECIFICATIONS	6
3.1	Sizing tankless water heaters	6
3.2	Tankless water heater accessories	7
3.3	Tankless water heater specifications	8
4	APPLICATIONS	9
4.1	Single Infiniti® K Installation	9
4.2	Pump sizing for circulation	10
4.2.1	External recirculation pump selection	11
4.2.1	Pump curves	12
4.2.2	Pump wiring setup	13
4.3	Domestic hot water circulation	14
4.3.1	Single Infiniti® K with domestic hot water recirculation installation	15
4.3.2	Domestic hot water recirculation with external pump	16
4.3.3	Adjusting the recirculation settings	16
4.4	Tank loading	17
4.4.1	Single Infiniti® K tank loading installation	18
4.4.2	Single Infiniti® K tank loading with recirculation installation	19
4.4.3	Multiple Infiniti® K tank loading installation	20
4.4.4	Multiple Infiniti® K tank loading with recirculation installation	21
4.5	Space heating	22
4.5.1	Single Infiniti® K with hydronic air handler installation	22

1 KEY TO SYMBOLS AND SAFETY INSTRUCTIONS

1.1 KEY TO SYMBOLS

WARNINGS

	<p>WARNING:</p> <p>Warnings in this document are identified by a warning triangle printed against a grey background. Keywords at the start of a warning indicate the type and seriousness of the ensuing risk if measures to prevent the risk are not taken.</p>
---	---

The following keywords are defined and can be used in this document:

- **DANGER** indicates a hazardous situation which, if not avoided, will result in death or serious injury.
- **WARNING** indicates a hazardous situation which, if not avoided, could result in death or serious injury.
- **CAUTION** indicates a hazardous situation which, if not avoided, could result in minor to moderate injury.
- **NOTICE** is used to address practices not related to personal injury.

IMPORTANT INFORMATION

	<p>This symbol indicates important information where there is no risk to people or property.</p>
--	--

1.2 SAFETY

PLEASE READ SAFETY PRECAUTIONS BEFORE INSTALLATION.

	<p>WARNING:</p> <p>These instructions are intended as an aid to qualified licensed service personnel for proper installation, adjustment and operation of this unit. Read these instructions thoroughly before attempting installation or operation. Failure to follow these instructions may result in improper installation, adjustment, service or maintenance and possibly resulting in fire, electrical shock, property damage, personal injury or death.</p>
---	---

	<p>WARNING:</p> <p>Disconnect all power to the unit before starting any service and maintenance. Failure to do so could cause severe electrical shock resulting in personal injury or death.</p>
---	---

	<p>WARNING: INSTALLATION REQUIREMENTS</p> <p>Installation or servicing of this unit can be hazardous due to parts, components and system pressure. Qualified and proper trained service personnel should perform installation and repair. Failure to do so could cause severe electrical shock resulting in personal injury or death.</p>
---	--

2 INTRODUCTION

This Applications Manual is intended to present some of the most common applications of the Infiniti® K Series tankless water heaters. Application drawings are shown with both piping and corresponding electrical schematics where applicable. Auxiliary equipment depicted does not necessarily represent any one manufacturer or specific model number. There are a wide variety of techniques, practices and piping strategies possible when installing water heating appliances. It is the responsibility of the installing contractor to determine the best solution for the application.



NOTICE: All drawings are conceptual in nature and do not address all design, installation or safety considerations. Additional safety and/or auxiliary equipment may be needed. Drawings are for reference use by officials, designers and licensed installers. It is expected that installers have adequate knowledge of accepted industry practices for the equipment, procedures, and applications involved. It is the responsibility of the installer to ensure that the installation is in accordance with local building codes.

Although this manual covers many common applications for our products, system possibilities are virtually endless. Should you encounter an application that is not covered in this manual or have any questions regarding any of its content, we encourage you to contact your local sales representative or us directly at Bradford White Corporation.

This manual is not a substitute for any of the appliance installation manuals. All specifications are subject to change.



Installation must conform with local codes or, in the absence of local codes, the National Fuel Gas Code ANSI Z223.1/NFPA 54.

In Canada: Installation must conform with CGA B149.(1,2) INSTALLATION CODES and/or local installation codes.

3 WATER HEATER SIZING AND SPECIFICATIONS

This section describes the Infiniti® K water heaters from Bradford White Corporation and provides a general overview to the specification sheets and model. More detailed information is contained in the installation manuals.

Download manuals at www.bradfordwhite.com.

3.1 SIZING TANKLESS WATER HEATERS

RULE OF THUMB SIZING

The tables below provide a general rule of thumb when sizing for most residential applications. For commercial applications or for a more detailed sizing method, use the Sizing by Chart instructions below in conjunction with the charts on the next page.

SIZING BY CHART

- Measure the flow rates at each fixture that will be used simultaneously and add them together. If only one application will be used at a time measure each fixture and use the maximum flow rate observed.
- Using a known volume container, record several fill times. Perform the calculation below to determine the flow rate (a one gallon fill time of 30 seconds is 2.0 gallons per minute (GPM)):

$$\text{Flow rate (GPM)} = \frac{\text{Volume (gallons)}}{\text{Fill time (sec)}} \times 60 \frac{\text{sec}}{\text{min}}$$

- Using a thermometer, measure the incoming water temperature. For reference, see average ground water temperature map. Subtract this temperature from the desired hot water temperature to get the degree rise. If the desired hot water temperature is 120F and incoming temperature is 55F, the desired degree rise is 65F.

EXAMPLE

- Required flow rate of 2.0 GPM at a 65°F rise.
- Refer to the graphs on page 10.

See Table 1 for multiple fixture possibilities and hot water flow rates at given inlet water temperatures with a water heater set point temperature of 120°F.

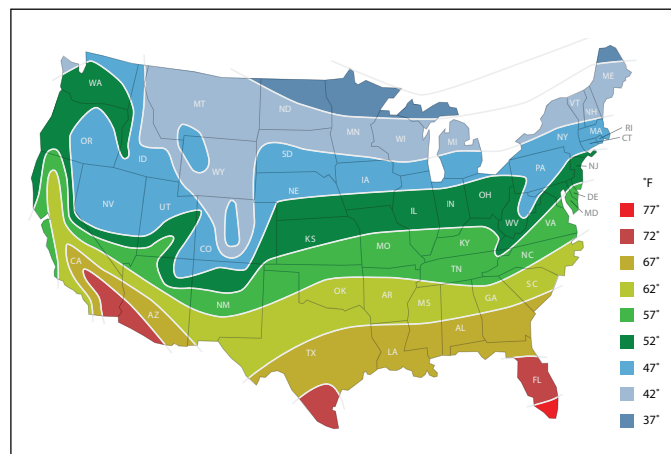

Figure 1: Average ground water temperatures



















MODEL	Inlet temperature (°F)								
	77°	72°	67°	62°	57°	52°	47°	42°	37°
Infiniti® K 199	 9.3 GPM	 8.3 GPM	 7.5 GPM	 6.9 GPM	 6.3 GPM	 5.9 GPM	 5.5 GPM	 5.1 GPM	 4.8 GPM
Infiniti® K 160	 7.5 GPM	 6.7 GPM	 6.1 GPM	 5.6 GPM	 5.1 GPM	 4.8 GPM	 4.4 GPM	 4.1 GPM	 3.9 GPM

Table 1: Maximum hot water flow rate at 120°F set point temperature

 Showerhead – 2 GPM

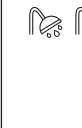
 Sink faucet – 1 GPM

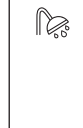
3.2 TANKLESS WATER HEATER ACCESSORIES

ACCESSORY	PART NUMBER
External NTC	7736505666
30' extension cable for outdoor HMI	7736505664
Aquastat Connector	7736505665

Table 2

3.3 TANKLESS WATER HEATER SPECIFICATIONS

DESCRIPTION	UNIT	RTG-K-160	RTG-K-199
Performance			
Maximum gas input ²	BTU/hr (kW)	160,000 (46.64)	199,000 (58.3)
Minimum input ³	BTU/hr (kW)	9,000 (2.6)	9,000 (2.6)
Maximum output	BTU/hr (kW)	57,608 (46.2)	119,701 (57.7)
Thermal efficiency (Efficiency in %)	%	> 99%	> 99%
Maximum flow rate at a 35 °F (19.4 °C) rise ¹	GPM (l/min)	9.0 (34)	11.2 (42.4)
Maximum flow rate at a 45 °F (25 °C) rise	GPM (l/min)	7.0 (26.7)	8.7 (27.9)
Maximum flow rate at a 55 °F (30.6 °C) rise	GPM (l/min)	5.8 (21.9)	7.2 (27.5)
Maximum flow rate at a 75 °F (41.7 °C) rise	GPM (l/min)	4.2 (15.9)	5.2 (19.7)
Maximum flow rate at a 90 °F (50 °C) rise	GPM (l/min)	3.5 (13.2)	4.4 (16.6)
Temperature Control⁴			
Selection range	°F (°C)	100 - 120 ⁵ (38 - 49)	100 - 120 ⁵ (38 - 49)
Default temperature ⁵	°F (°C)	120 (49)	120 (49)
Temperature stability ⁶	°F (°C)	± 2 (± 1)	± 2 (± 1)
Gas Requirement			
Gas connection	inches	¾"	¾"
Inlet gas pressure range NG / LP 7	Inch W.C.	3.5" - 10.5" / 8" - 13"	3.5" - 10.5" / 8" - 13"
Water			
Top hot water connection NPT	inches	¾"	¾"
Top cold water connection NPT	inches	¾"	¾"
Minimum water flow ⁸	GPM (l/min)	0.45 (1.7)	0.45 (1.7)
Maximum water pressure	PSI (bar)	150 (10.3)	150 (10.3)
Minimum recommended water pressure	PSI (bar)	18 (1.2)	18 (1.2)
Minimum well pressure	PSI	30	30
Water valve material	-	Polymer (PPS) (Polypropylene)	Polymer (PPS) (Polypropylene)
Combustion			
CO level	ppm	≤ 250 (measured)	≤ 250 (measured)
CO2 level (set from factory)	%	see installation manual	see installation manual
Weight			
Net weight	pounds (kg)	73.2 (33.20)	77.5 (35.15)
Gross weight	pounds (kg)	79.37 (36.0)	83.67 (37.95)
Electrical			
Voltage	V AC	120	120
Frequency	Hz	60	60
Amperage (Idle)	mA	40	40
Amperage (operation)	A	≤ 2.7	≤ 2.7
Water protection ⁹	IP	X4D	X4D
Venting			
Venting category	-	IV	IV
Approved vent or combustion air pipe material - United States	-	PP fl exible/concentric/rigid, PVC sched. 40, PVC-DWV, CPVC sched. 40, ABS-DWV sched. 40	
Approved vent or combustion air pipe material - Canada	-	CSA or ULC certified only (ULCS636)	

Table 3

¹ These flow are based upon setting the unit to higher temperatures and then mixing down using cold water after the unit, to reach these flow rates.

² Input rating is based on sea level operation and need not be changed for operation up to 2000 ft (610 m) elevation. For operation at elevations above 2000 ft (610 m), input rating is automatically reduced at the rate of 4 percent for each 1000 ft (305 m) above sea level.

³ When converted to LPG the minimum input is 17000 BTU/hr (5 kW).

⁴ With constant flow.

⁵ Can be programmed to achieve up to 140 °F (60 °C).

⁶ Requirements: Steady flows, single unit installations, up to 140 °F (60 °C).

⁷ To measure Gas Pressure, see installation manual - Measuring Gas Pressure, chapter 4.13, page 36.

⁸ Refers to activation point. Deactivation point value is 0.35GPM (1.3 l/min).

⁹ Protection against water drops.

4 APPLICATIONS

4.1 SINGLE INFINITI® K INSTALLATION

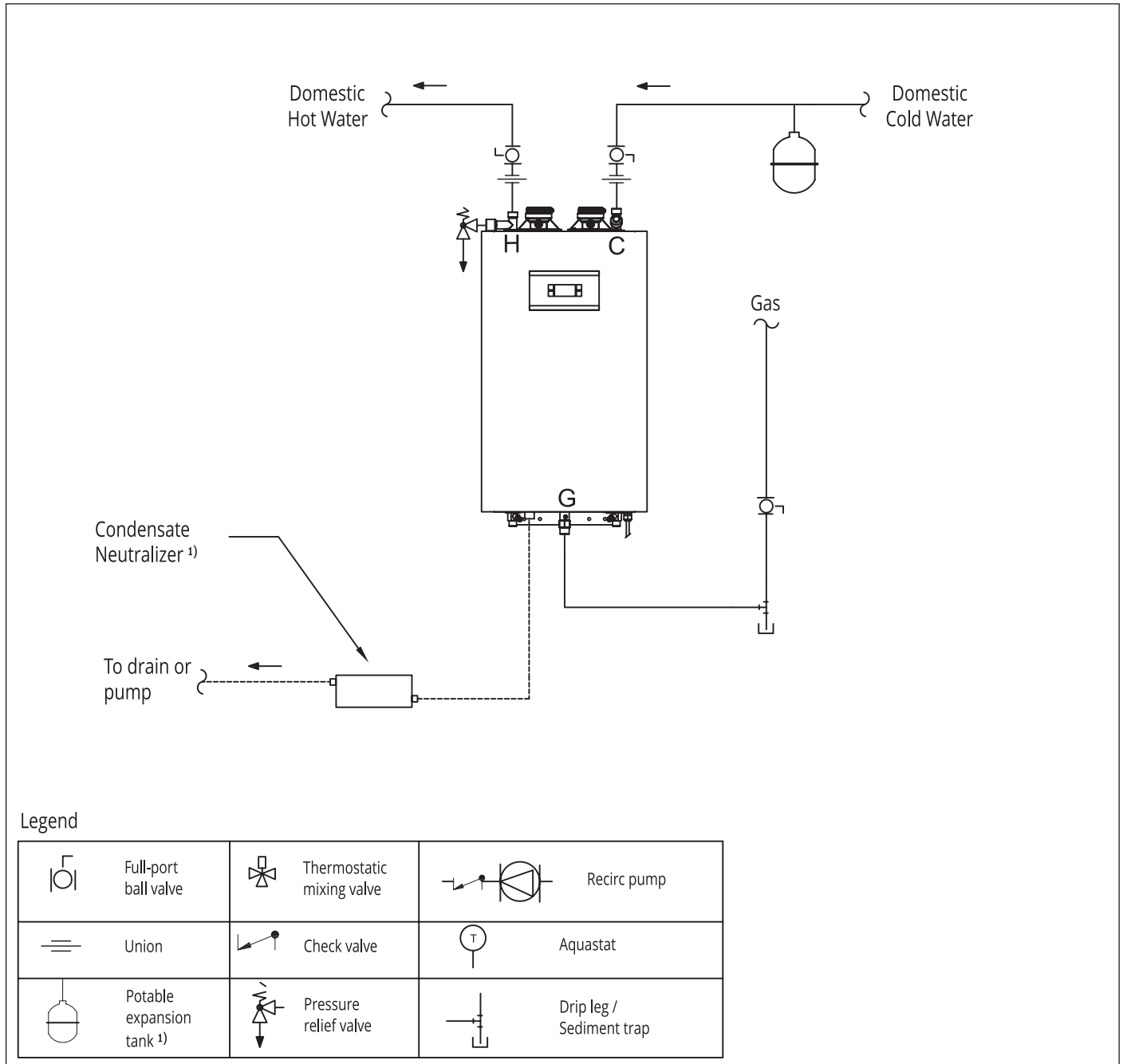

¹⁾ as required by local code

DISCLAIMER: This drawing is conceptual in nature, not to scale and for reference only. Additional functional, installation, and safety devices may be needed or required. All work pertaining to the installation shall be in full compliance with all legal requirements, including national and local codes. Best installation practices should be followed.

4.2 PUMP SIZING FOR CIRCULATION

The following section outlines pump sizing for domestic hot water recirculation and tank loading. Only models approved for such applications are listed in this section.



For direct DHW recirculation and tank loading applications: Run the system for 30 minutes to remove debris from the plumbing. Then remove the unit's inlet water filter to decrease pressure drop through the system. If the inlet water filter, when removed, contains debris, it is recommended to install a 40 mesh Y-strainer (installer supplied) on the cold water inlet.

- Size the pump according to the pressure drop curve of your Infiniti® K model (fig. 1 below) and the loop pressure drop tables.
- Maximum flow allowed for tank loading through the pump loop is 5 GPM.
- Must be 0.45 gpm to activate unit
- DHW recirc loop pump must circulate enough gpm to account for normal loop heat loss and to ensure that the recirc pump eventually satisfies and turns off

PRESSURE DROP CURVE

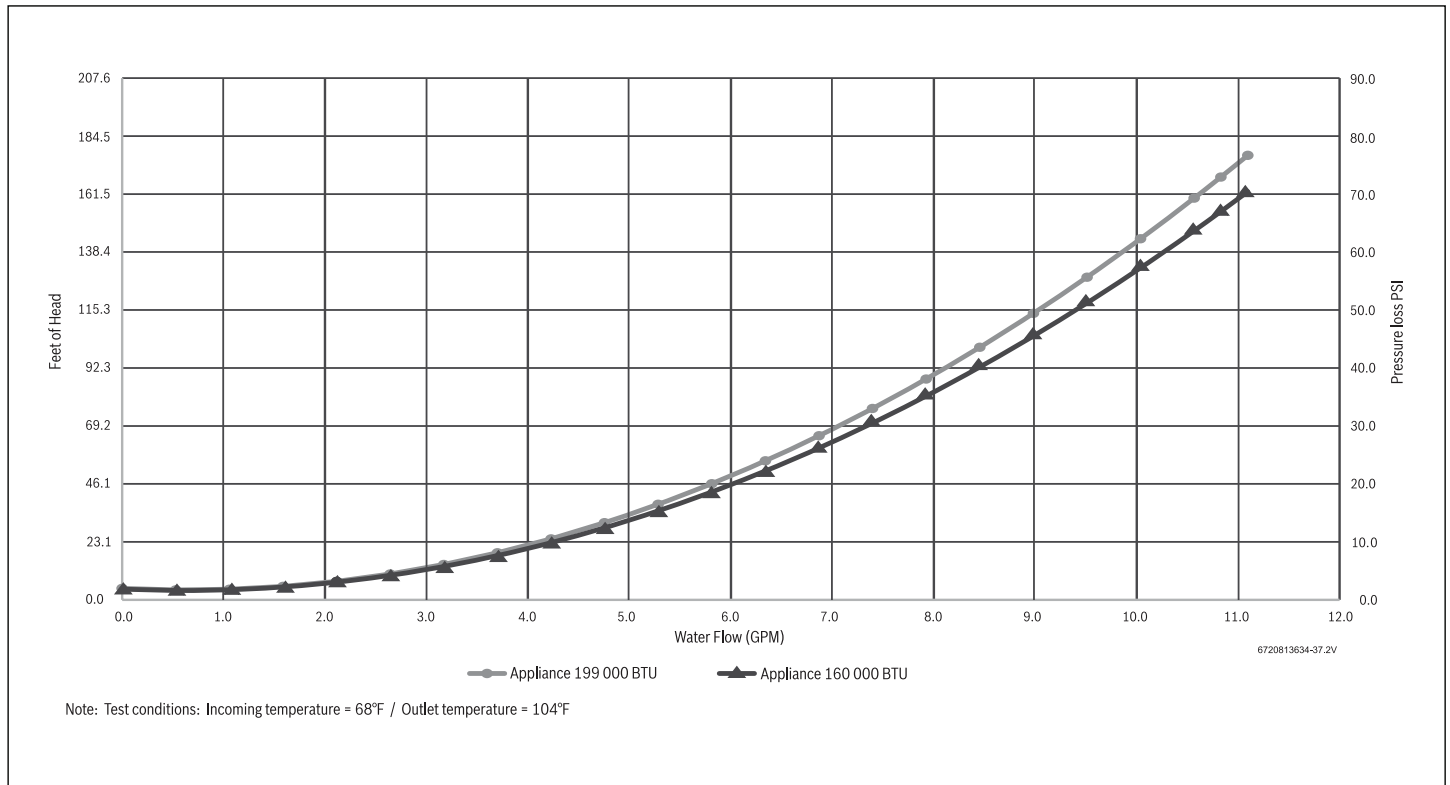

Figure 2

4.2.1 EXTERNAL RECIRCULATION PUMP SELECTION

DEDICATED RECIRCULATION LINE RECOMMENDED PUMPS

Timer Controlled

Manufacturer	Model
Taco	008-SF6* (Pump) & 265-1 or 265-3 (External Timer)
Grundfos	UP 15-55 SUC/TLC
Bell & Gossett	NBF-36* (Pump) & TC-1 (External Timer)

INFINITI K Controlled

Manufacturer	Model
Taco	008-SF6*
Grundfos	UP 15-55 SUC/TLC†
Bell & Gossett	NBF-36*

* Indicates flange connections

† Place timer to be on all day and allow K-Series to control on/off

DISCLAIMER: Pump recommendations above are based on up to a 500 feet total piping loop length. There are many possible pumps other than those listed above that could work based on the application.

CROSS OVER VALVE RECIRCULATION LINE RECOMMENDED PUMPS

Timer Controlled

Manufacturer	Model
Taco	0011-BF4* (Pump) & 265-1 or 265-3 (External Timer)
Grundfos	UP 26-99 SF* (Pump) & 505474 (External Timer)
Bell & Gossett	NBF-36* (Pump) & TC-1 (External Timer)

* Indicates flange connections

DISCLAIMER: Pump recommendations above are based on up to a 500 feet total piping loop length and one bypass valve. There are many possible pumps other than those listed above that could work based on the application.

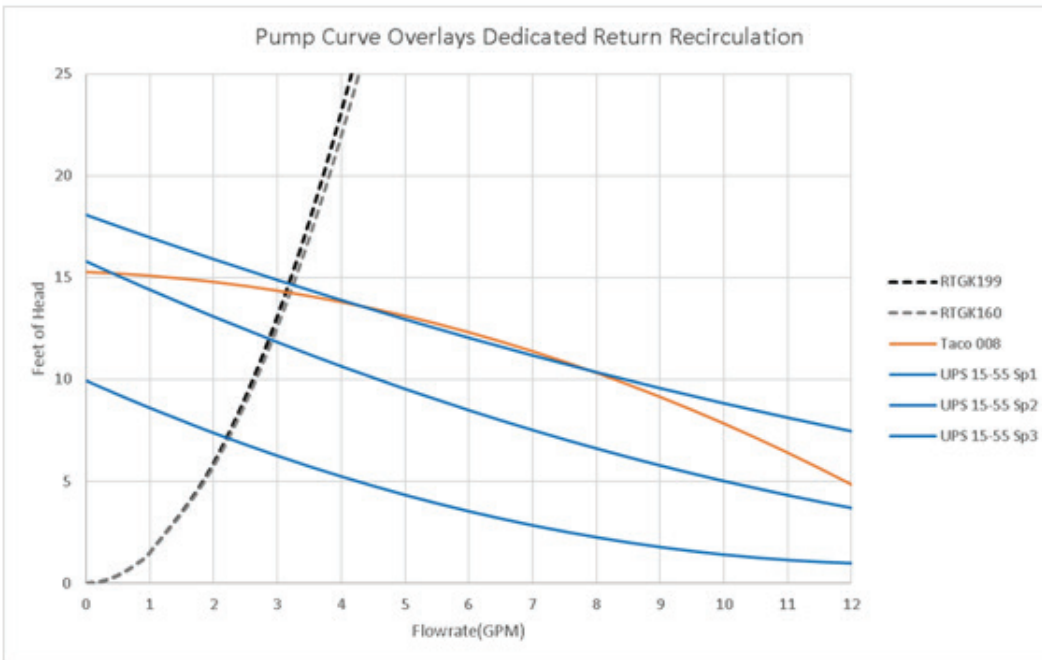
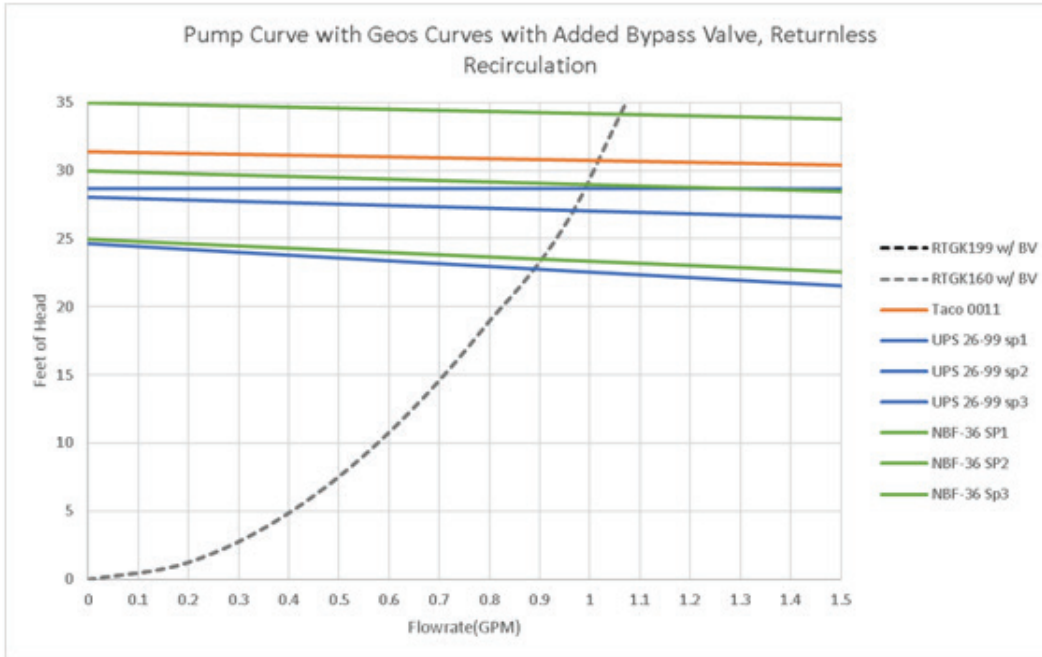

4.2.2 PUMP WIRING SETUP

EXTERNAL TIMER CONTROLLED PUMP WIRING

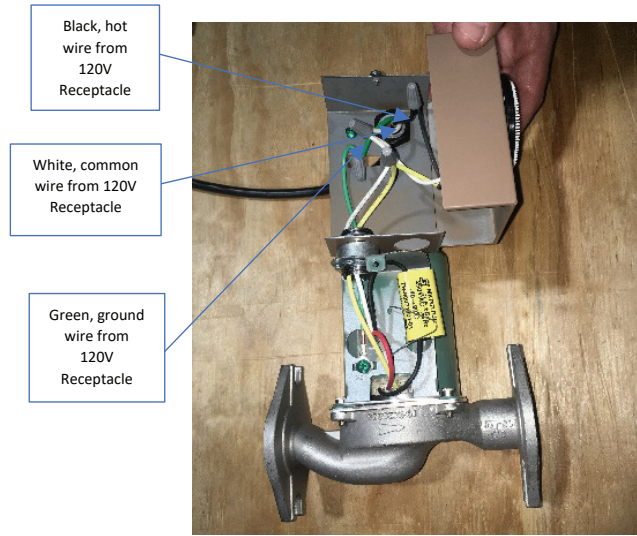

INFINITI K CONTROLLED PUMP WIRING

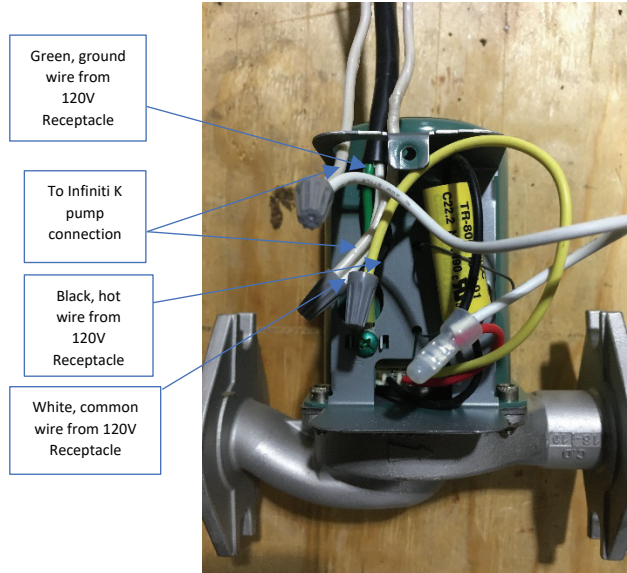
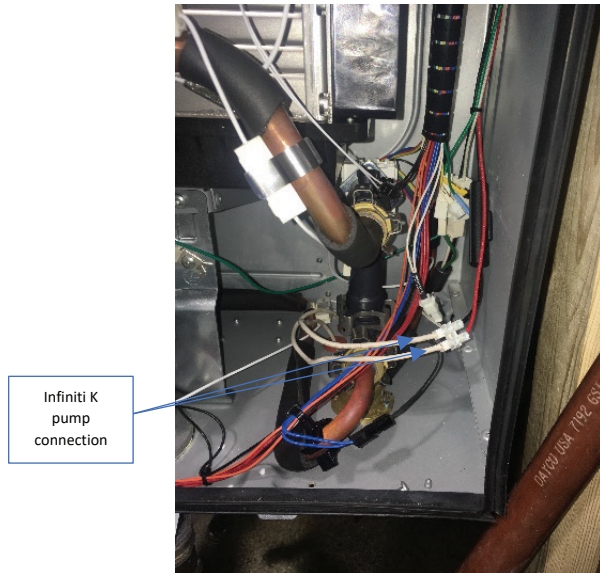

DISCLAIMER: Images are for reference only and all installations must comply with local installation codes, or in the absence of local codes, the National Electric Code.

4.3 DOMESTIC HOT WATER CIRCULATION



System conditions vary and each pump must be sized by a professional to insure performance.

Refer to pump manufacturers flow vs pressure specifications to select a pump that can provide adequate flow while overcoming the pressure loss through the Infiniti® K and the recirculation loop. Refer to figure 2 to determine pressure loss.



Use only bronze or stainless steel pumps. Do not use pumps of iron construction as they will oxidize and clog the inlet filter on the appliance.

- When properly installed in a direct recirculation application the Infiniti® K will regulate water temperature in a recirculation loop. A thermostatic mixing valve should be used if your setpoint is greater than 120°F.
- When the loop temperature is within 1.8°F degrees of setpoint the pump will turn off.
- When the loop temperature is 1.8°F degrees less than the setpoint the pump will turn on.
- Infiniti® K pump will also turn off after approximately 1 minute in cases where there is no flow thru the recirculation loop such as when a crossover valve is installed at the farthest fixture. Unit will check for flow after approximately 4 minutes by operating the pump for 10 seconds in order to determine if the crossover valve has reopened.

EXAMPLE

- Infiniti® K temperature setting: 120°F
- Pump turn ON temperature $\leq 118^\circ\text{F}$
- To minimize energy costs:
 - Insulate all pipes in the recirculation loop.

RECIRCULATION LOOP PRESSURE DROP AT 2GPM (FEET OF HEAD)

Material	10 ft Pipe	90° Elbow	45° Elbow	Tee Branch
½" Type L Copper	0.85	0.09	0.05	0.18
¾" Type L Copper	0.15	0.03	0.01	0.05
¾" Pex	0.25	0.02	N/A	0.03
⅝" Pex	0.53	0.04	N/A	0.06
½" Pex	1.3	0.12	N/A	0.18

Table 4

Source: 2009 International Plumbing Code

For other desired gpm flow rates, please consult IPC for appropriate pressure drop.

EXAMPLE

Sizing a pump for a 2gpm direct DHW recirc system with an Infiniti® K 199 and have 150 ft total loop length.

HEAD LOSS	LOOP COMPONENT
9.00 ft	Infiniti® K 199 (See Fig.2, page 10)
1.20 ft	80 ft of ¾" copper
5.90 ft	70 ft of ½" copper return
0.24 ft	8 x ¾" 90 elbows
0.10 ft	2 x ¾" Tees (branch)
0.72 ft	8 x ½" 90 elbows
+ 0.18 ft	1 x ½" Tee (branch)
17.34 ft	Minimum Pump Head at 2.0 gpm

Once the loop head loss has been calculated, use the pump manufacturer's performance curves to select the proper potable water circulator at the required flow rate.

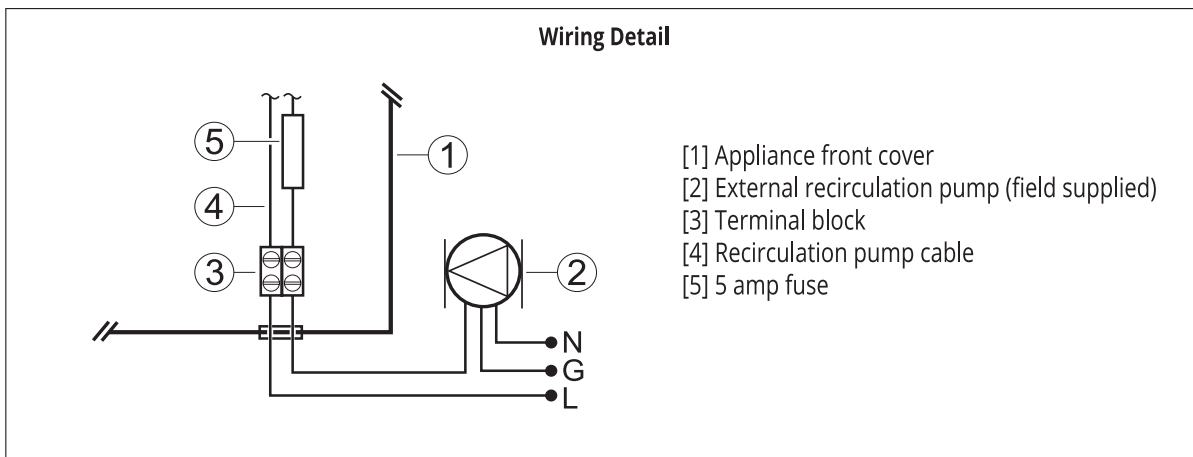

4.3.1 SINGLE INFINITI® K WITH DOMESTIC HOT WATER RECIRCULATION INSTALLATION

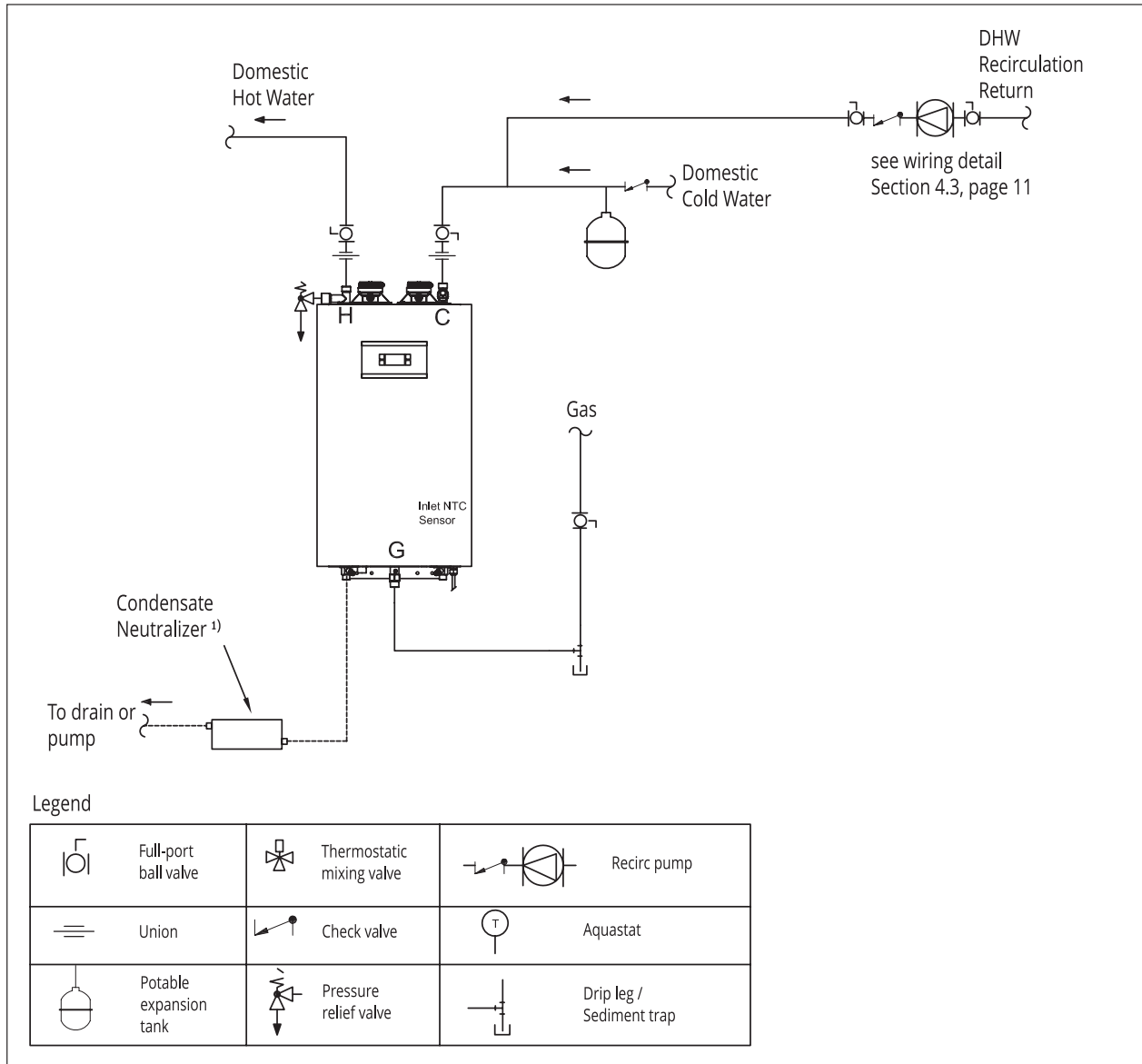

EXTERNAL RECIRCULATION PUMP

- Max pump amp draw: 5 amps
- Recirc temperature differential is defined by using built-in tankless controller
- Pump is powered only when inlet temperature sensor is less than the setpoint temperature of the unit by a fixed differential
- See Section 4.3.2, for specific temperature values

DISCLAIMER: This drawing is conceptual in nature, not to scale and for reference only. Additional functional, installation, and safety devices may be needed or required. All work pertaining to the installation shall be in full compliance with all legal requirements, including national and local codes. Best installation practices should be followed.

4.3.2 DOMESTIC HOT WATER RECIRCULATION WITH EXTERNAL PUMP

The following drawing is provided to outline one possible recirculation design. This schematic is for illustration only and must not be used for actual installation without appropriate engineering and technical advice from a properly licensed professional in the locality where the installation is made.

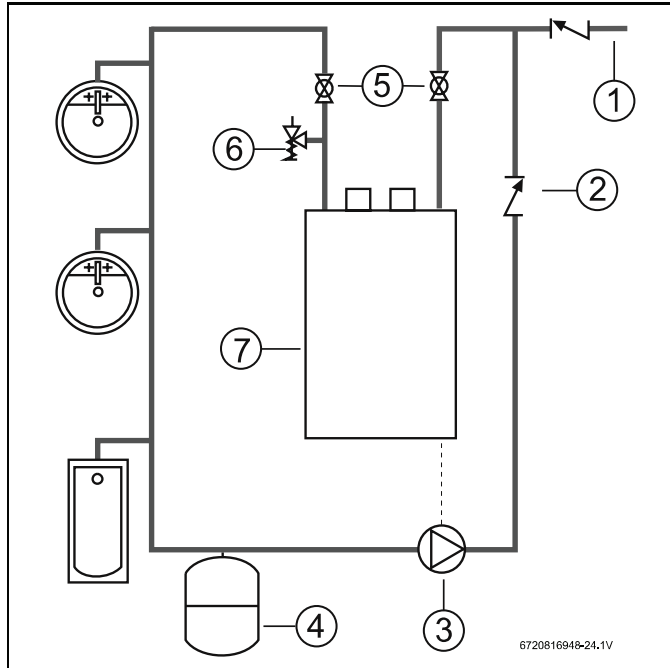

Fig. 29 Recirculation application

- [1] Cold water supply
- [2] Check valve
- [3] Circulator pump
- [4] Expansion tank
- [5] Shutoff valves
- [6] PRV
- [7] RTG-K-160/199N/XI

4.3.3 ADJUSTING THE RECIRCULATION SETTINGS

The pump and burner turn ON and OFF based on a delta between the set point temperature on the water heater and the inlet water temperature sensor value. This delta is called the **comfort level**.

The higher the comfort level, the smaller the delta between the set point temperature on the water heater and the inlet water temperature sensor value, resulting in a hotter recirculation system.

The smaller the comfort level, the larger the delta between the set point temperature on the water heater and the inlet water temperature sensor value, resulting in a cooler recirculation system.

Below is a graph illustrating how the comfort level value changes the recirculation system's temperature.

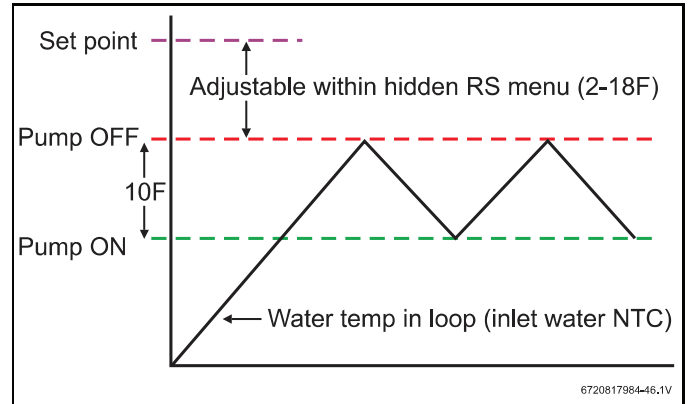

Fig. 30 Pump activation and deactivation thresholds

Comfort level	Delta T (° F)
1	18
2	16
3	14
4	12
5	10
6	8
7	6
8	4
9	2

Table 17

RS Menu



A higher comfort level will result in longer pump run times, which will consume more electricity and gas.

The **comfort level** can be adjusted to achieve the desired balance between readiness of hot water at the point of use and energy consumption.

4.4 TANK LOADING

Tank loading pairs tankless water heaters with storage tanks to maximize peak flow for high demand applications. A tank load system, because of the added storage, can provide a high peak flow with fewer tankless units and lower installed cost.

Tank loading is recommend for high cycle applications such as commercial kitchens with hand sprayers.

THESE GUIDELINES SHOULD BE FOLLOWED TO MAXIMIZE SYSTEM OUTPUT:

- Ensure flow through each water heater is between 3.5-5.0 gpm. See recommended pump models in application section of this manual.
- For best performance, plumb the system or configure the tank to draw cold supply water into the water heater during hot water use.
- Maintain a 20 degree temperature difference between tankless set-point and desired tank temperature.
- Do not use a cascading kit in a tank loading application.
- When multiple tankless water heaters are used, the total equivalent length of piping to each unit should be kept roughly equal. A reverse return piping scheme is recommended to equalize flow through each water heater.
- For tank temperature settings above 120°F, the Bradford White commercial model should be used.

RECIRCULATION LOOP PRESSURE DROP AT 2GPM (FEET OF HEAD)

Material	10 ft Pipe	90° Elbow	45° Elbow	Tee Branch
¾" Type L Copper	0.48	0.1	0.03	0.15
1" Type L Copper	0.14	0.04	0.02	0.07
1.25" Type L Copper	0.06	0.02	0.01	0.04
1.5" Type L Copper	0.03	0.01	<0.01	0.02
2" Type L Copper	0.01	<0.01	<0.01	0.01

Table 5

Source: 2009 International Plumbing Code

PRESSURE DROP VS. FLOW

# of units	Infiniti™ K 160	Infiniti™ K 199
1	20 feet of head @ 4gpm	21 feet of head @ 4gpm
2	20 feet of head @ 8gpm	21 feet of head @ 8gpm
3	20 feet of head @ 12gpm	21 feet of head @ 12gpm
4	20 feet of head @ 16gpm	21 feet of head @ 16gpm
5	20 feet of head @ 20gpm	21 feet of head @ 20gpm
6	20 feet of head @ 24gpm	21 feet of head @ 24gpm
7	20 feet of head @ 28gpm	21 feet of head @ 28gpm
8	20 feet of head @ 32gpm	21 feet of head @ 32gpm
9	20 feet of head @ 36gpm	21 feet of head @ 36gpm
10	20 feet of head @ 40gpm	21 feet of head @ 40gpm

Table 6

EXAMPLE

Sizing a pump for a 4GPM tank loading DHW system with a Infiniti® K 199 and a 20 ft total loop length.

HEAD LOSS LOOP COMPONENT

22.00 ft	Infiniti® K 199 (See Fig.2)
1.00 ft	20 ft of ¾ copper
0.80 ft	8 x ¾" 90 elbows
+ 0.30 ft	2 x ¾" Tees (branch)

24.1 ft Minimum Pump Head at 4.0 gpm

Once the loop head loss has been calculated, use the pump manufacturer's performance curves to select the proper potable water circulator at the required flow rate.

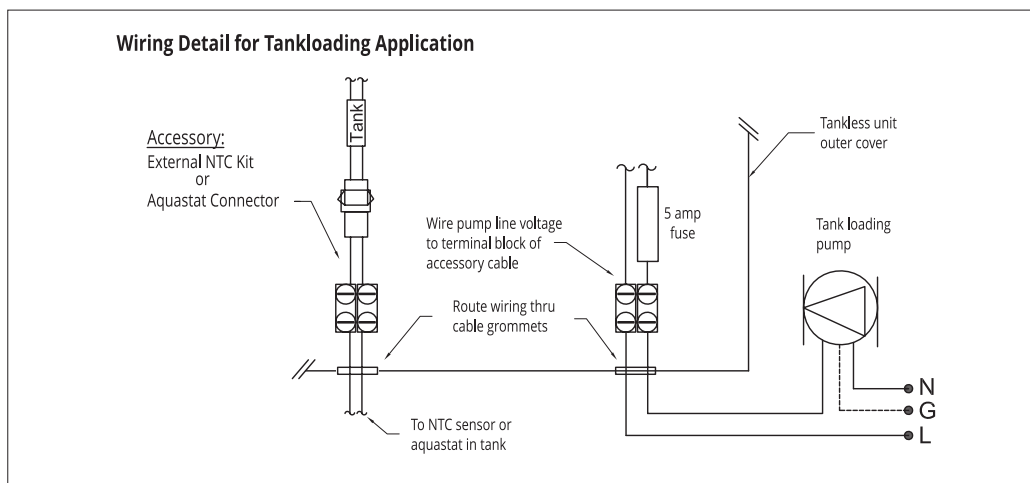

4.4.1 SINGLE INFINITI® K TANK LOADING INSTALLATION

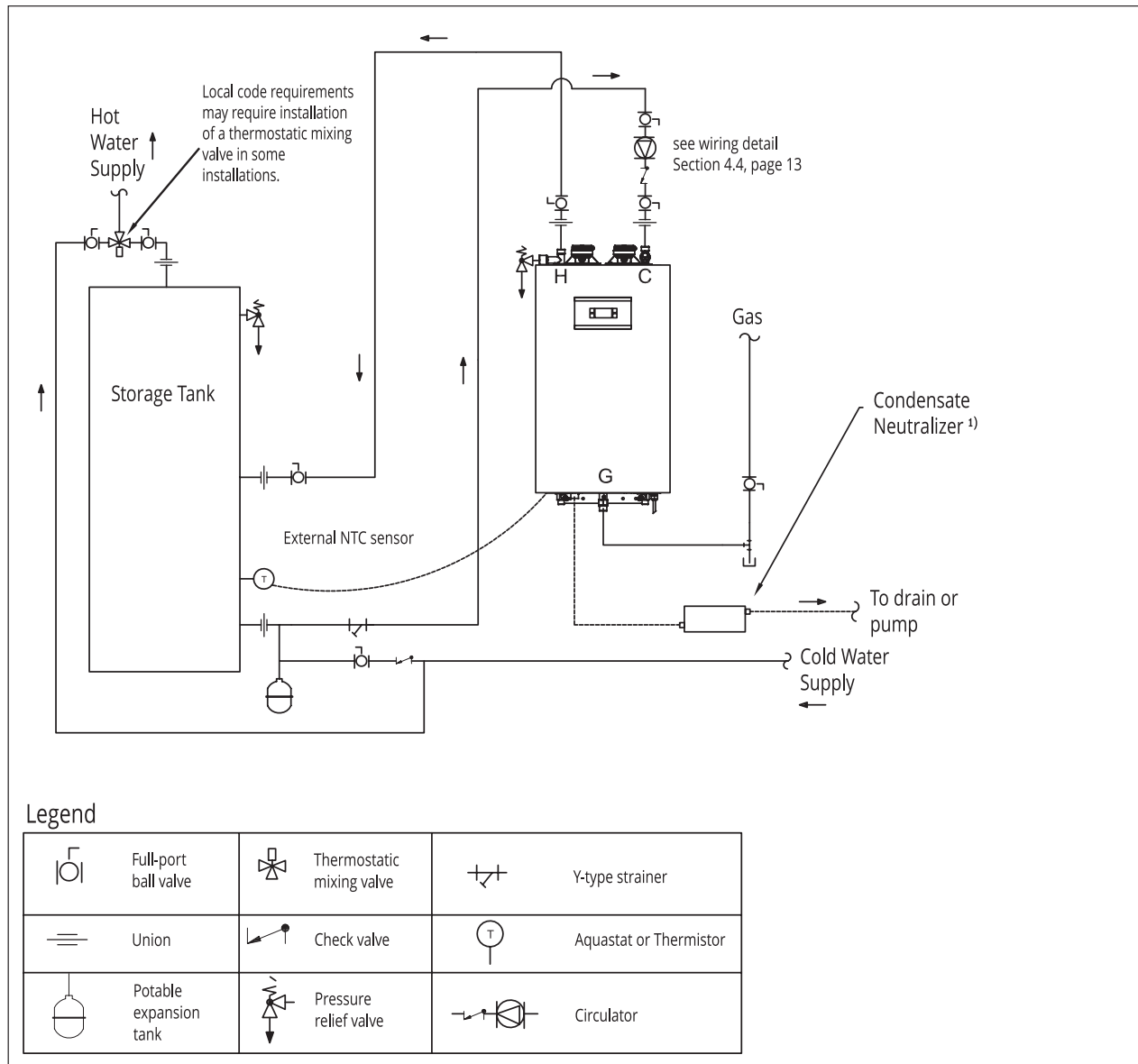

RECOMMENDED PUMP

Manufacturer	Model
Grundfos	UP 26-99 SF
Taco	0013 SF3
B & G	PL-36B

Table 7

DISCLAIMER: This drawing is conceptual in nature, not to scale and for reference only. Additional functional, installation, and safety devices may be needed or required. All work pertaining to the installation shall be in full compliance with all legal requirements, including national and local codes. Best installation practices should be followed.

4.4.2 SINGLE INFINITI® K TANK LOADING WITH RECIRCULATION INSTALLATION

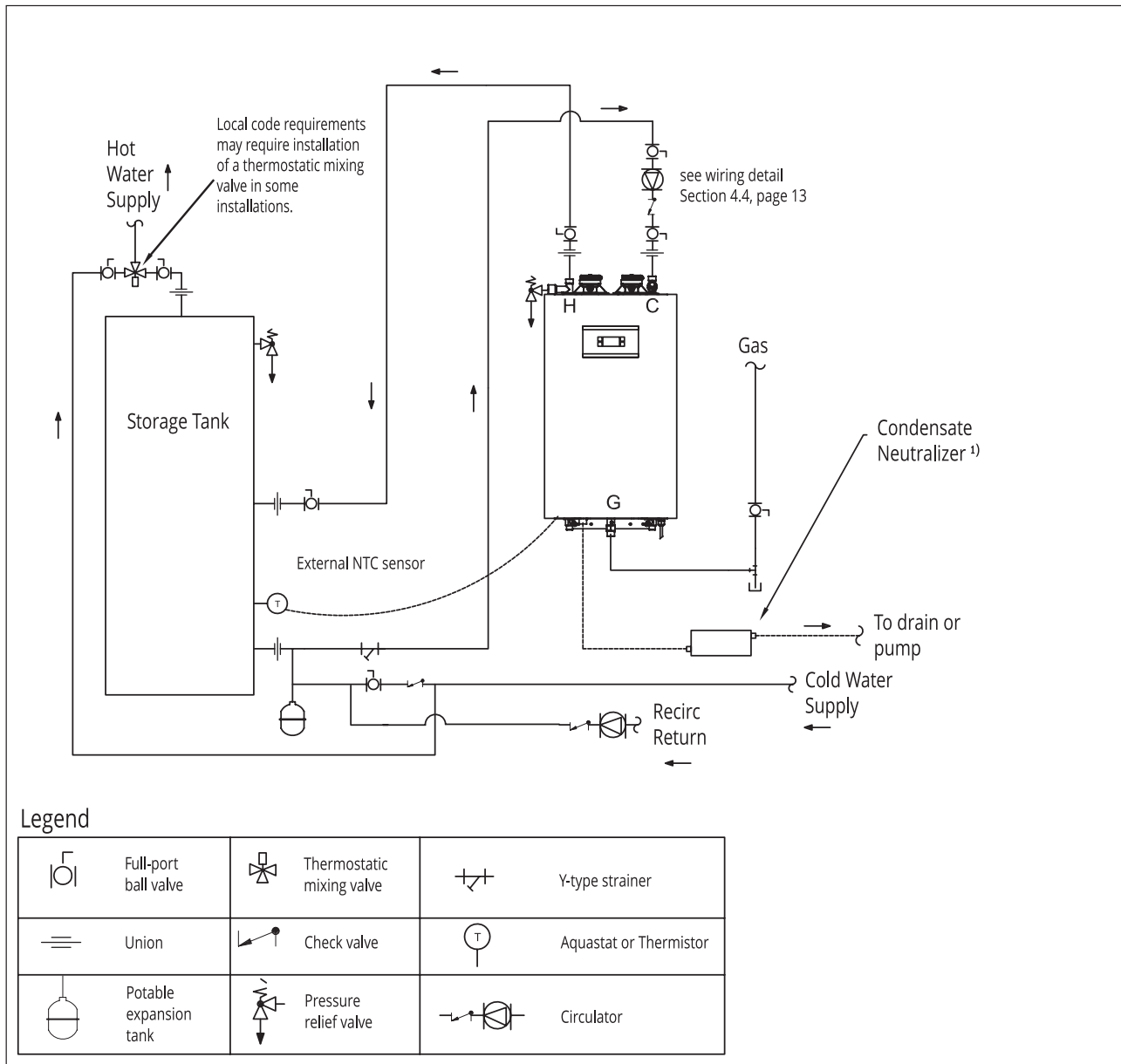

¹⁾ as required by local code

RECOMMENDED PUMP

Manufacturer	Model
Grundfos	UP 26-99 SF
Taco	0013 SF3
B & G	PL-36

Table 7

DISCLAIMER: This drawing is conceptual in nature, not to scale and for reference only. Additional functional, installation, and safety devices may be needed or required. All work pertaining to the installation shall be in full compliance with all legal requirements, including national and local codes. Best installation practices should be followed.

4.4.3 MULTIPLE INFINITI® K TANK LOADING INSTALLATION

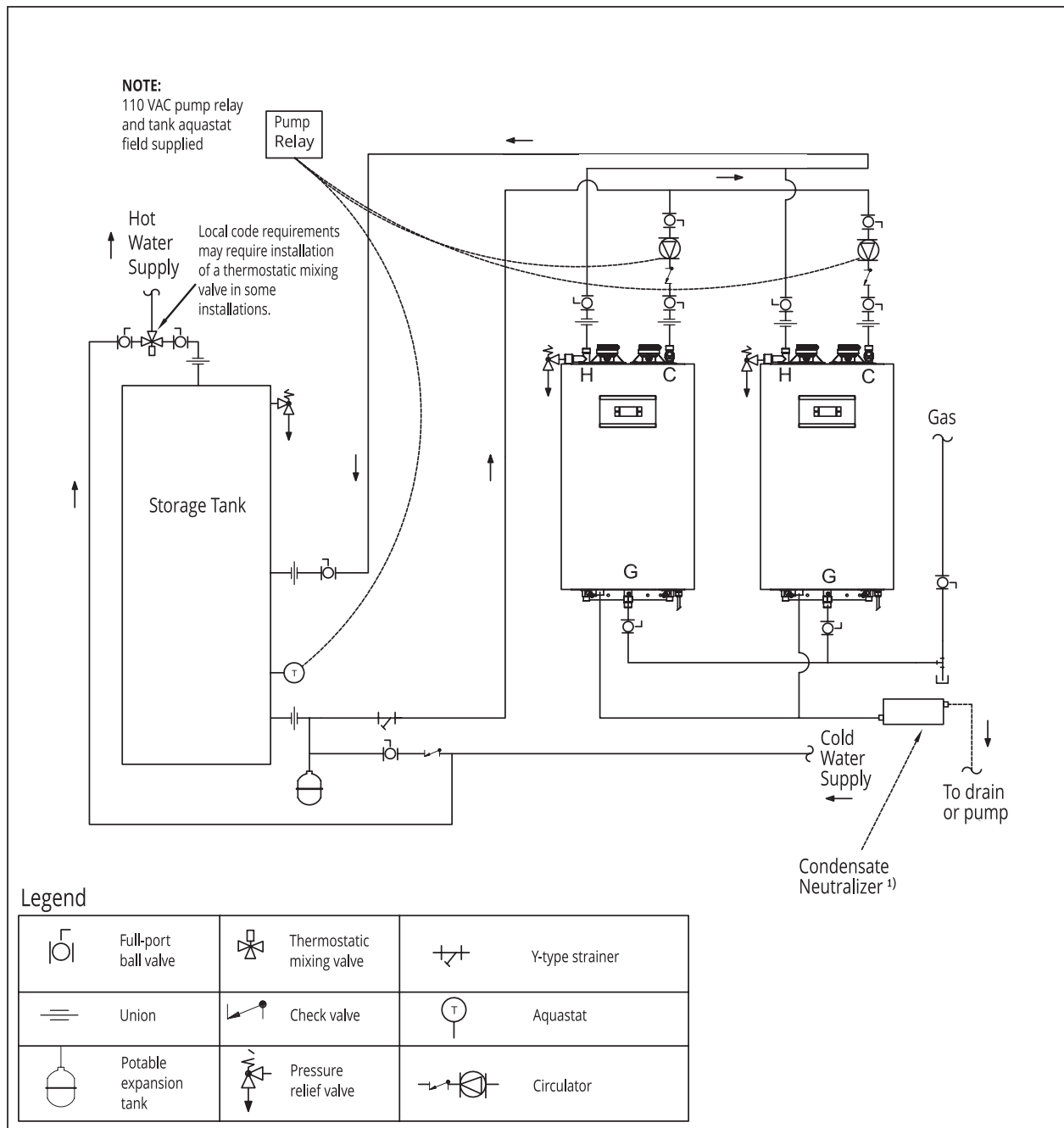

¹⁾ as required by local code

DISCLAIMER: This drawing is conceptual in nature, not to scale and for reference only. Additional functional, installation, and safety devices may be needed or required. All work pertaining to the installation shall be in full compliance with all legal requirements, including national and local codes. Best installation practices should be followed.

4.4.4 MULTIPLE INFINITI® K TANK LOADING WITH CIRCULATION INSTALLATION

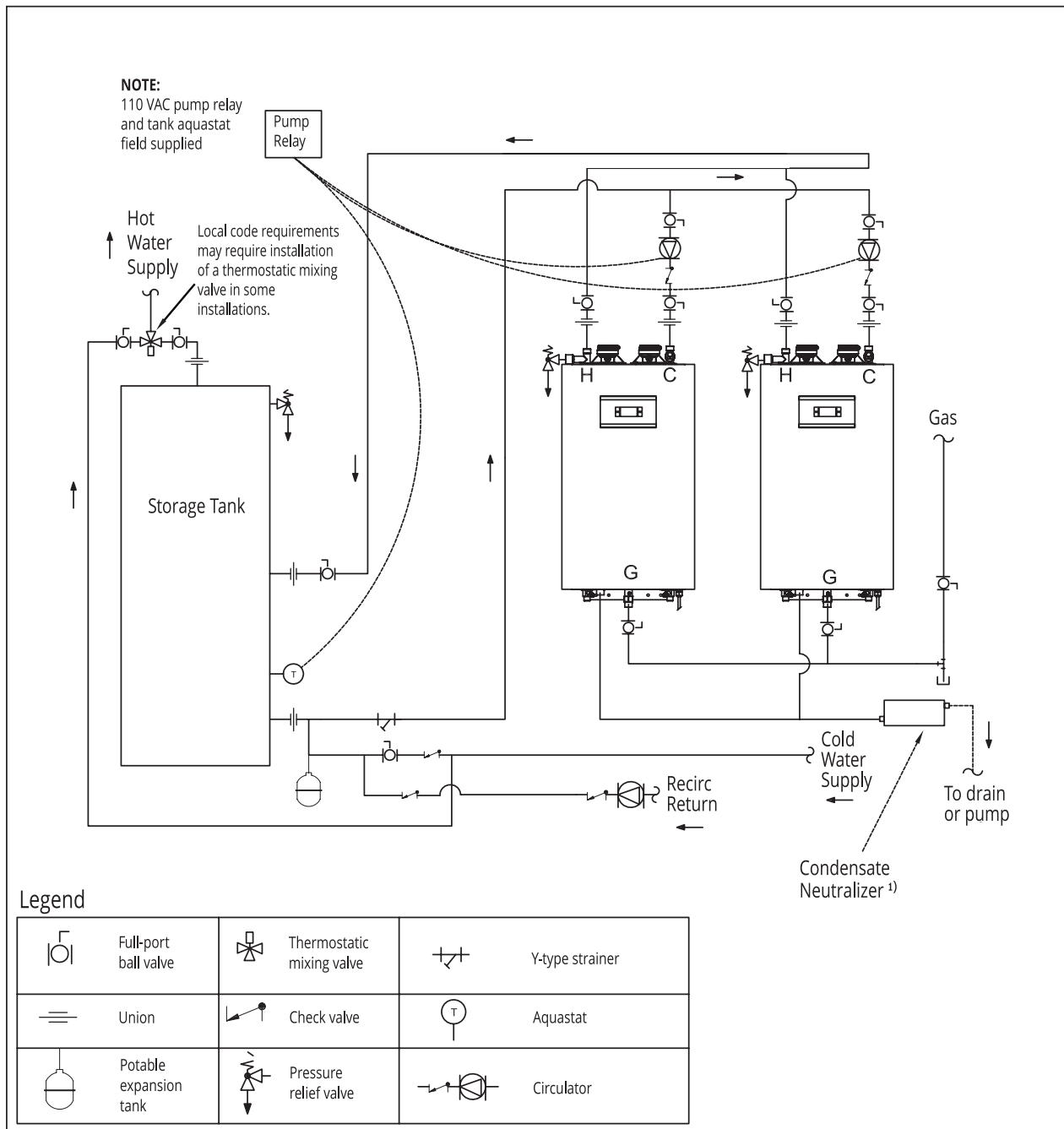

¹⁾ as required by local code

DISCLAIMER: This drawing is conceptual in nature, not to scale and for reference only. Additional functional, installation, and safety devices may be needed or required. All work pertaining to the installation shall be in full compliance with all legal requirements, including national and local codes. Best installation practices should be followed.

4.5 SPACE HEATING

4.5.1 SINGLE INFINITI® K WITH HYDRONIC AIR HANDLER INSTALLATION

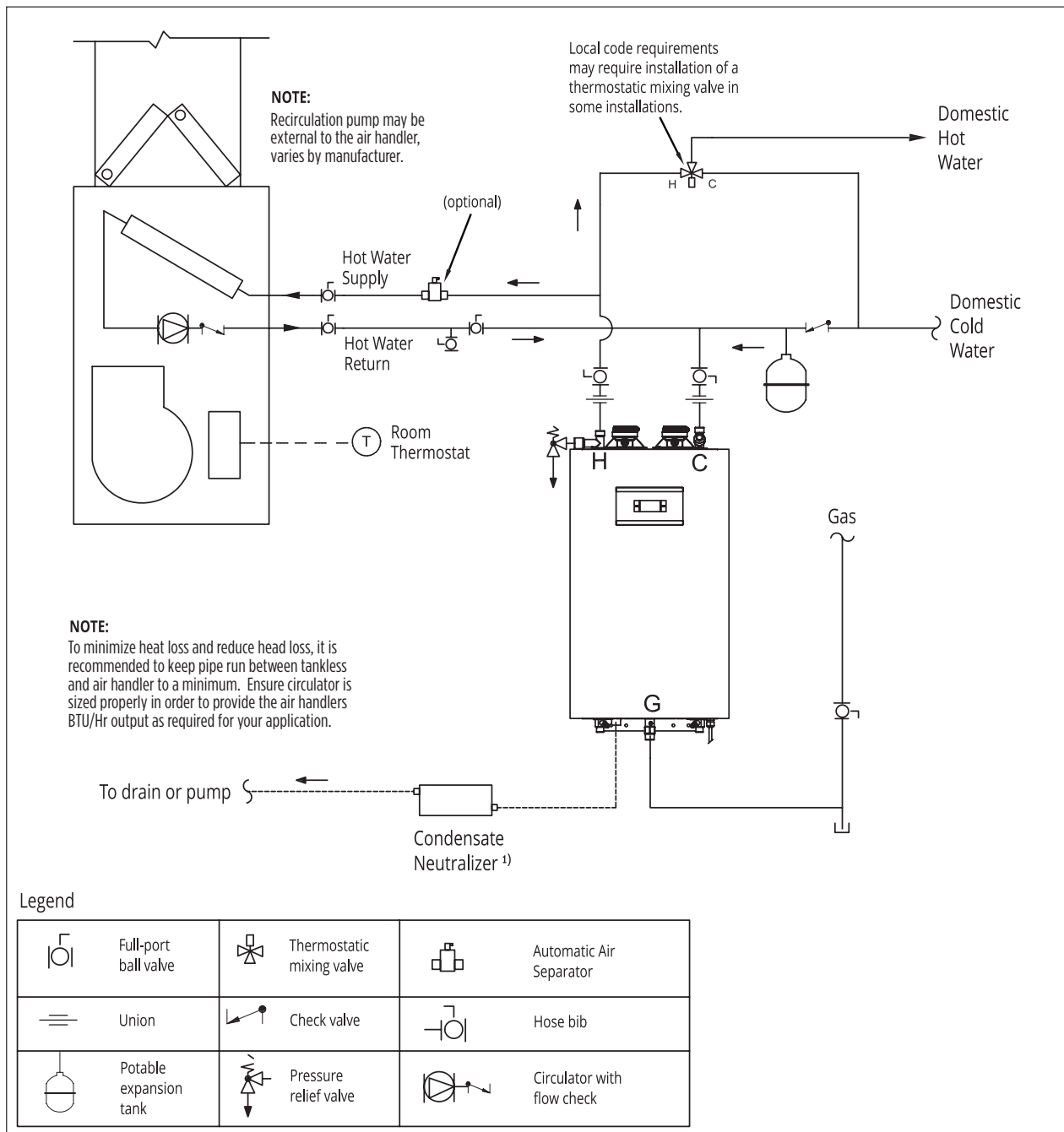

¹⁾ as required by local code

This Page is Intentionally Blank



BRADFORD WHITE®

W A T E R H E A T E R S

Ambler, PA

For U.S. and Canada field service,
contact your professional installer or
local Bradford White sales representative.

Sales/800-523-2931

Technical Support/800-334-3393
Email/techserv@bradfordwhite.com

Warranty/800-531-2111
Email/warranty@bradfordwhite.com

Service Parts/800-538-2020
Email/Parts@bradfordwhite.com

International:
international@bradfordwhite.com



BRADFORD WHITE™ **CANADA**

Halton Hills, Ontario, Canada

Sales & Technical Support/866-690-0961
905-203-0600

Fax/905-636-0666

Email

Warranty/bwccwarranty@bradfordwhite.com
Technical Support/BWCCTech@bradfordwhite.com
Parts/orders@bradfordwhitecanada.com
Orders/ca.orders@bradfordwhite.com

www.bradfordwhite.com